

ETT-R&D Publications
IT Professional, Author / Researcher
Internet Draft
Category: Proposed Standard
Document: draft-terrell-internet-protocol-t1-t2-ad-sp-05.pdf
Expires October 15, 2002

E. Terrell
April 2002

INTERNET PROTOCOL t1 and t2 ADDRESS SPACE

Status of this Memo

This document is an Internet-Draft, and is in full conformance with all provisions of Section 10 of RFC2026. Internet-Drafts are working documents of the Internet Engineering Task Force (IETF), its areas, and its working groups. Note that other groups may also distribute working documents as Internet-Drafts. Internet-Drafts are draft documents valid for a maximum of six months and may be updated, replaced, or obsolete by other documents at any time. It is inappropriate to use Internet-Drafts as reference material or to cite them other than as "work in progress". The list of current Internet-Drafts can be accessed at <http://www.ietf.org/ietf/lid-abstracts.txt>. The list of Internet-Draft Shadow Directories can be accessed at <http://www.ietf.org/shadow.html>.

Conventions

Please note, the font size for the Tables are smaller than the expected 12 pts. However, if you are using the most current Web Browser, the View Section of the Title bar provides you with the option to either increase or decrease the font size for comfort level of viewing. That is, provided that this is the HTML or PDF version.

TABLE OF CONTENTS

Abstract

Introduction: Analysis and Impact of the IPv4 Internet Protocol Address Space, which Questions the Current Use and Application of the 'CIDR Notation'

Chapter I: Analysis IPv4, IPT1, and IPT2 address space using the HD-Ratio

Chapter II: Suggestion for the IPT1 and IPT2 Internet Protocol Address Space, Supernetting and the New 'CIDR' Notation

Chapter III: IPT1 and IPT2; The APRA and IN-ADD.APRA Addresses

Chapter IV: Security

Appendix I: IPT1 Internet Protocol Address Space

Appendix II: Mathematical Analysis of the Structure, and the Definition of the IPTX Protocol(s) Addressing System. And the Future; which suggest a Different Reality regarding the Internet, and Networking, using the IPTX Protocol Specification. (Parts 1 and 2)

Appendix III: Consolidation of Infinity; The Reality of the 2 Tier Base Foundation of the 'IPTX' Protocol Family Specification

References

E Terrell

[Page 2]

IPT1 and IPT2 ADDRESS SPACE

October 15, 2002

Abstract

This paper Defines the 'IPtX Protocol Specification', and provides a visualization of the lack of IP Address Control, a Blunder, which may be excused partly because of the impossibility of Predicting the Current, as well as the Future use and growth of the Internet. However, this requires an investigation, or Analysis for the Current use of the HD-Ratio in the IPv4 and IPv6 IP Specifications. Moreover, while the IPv4 IP Specification, is indeed the primary focus of this investigation. To provide a fair comparison however, this Analysis requires, if not mandates, the use of the IPt1 and IPt2 specifications as well. The reasoning here nevertheless, is the difference in the respective Addressing Schematics. Where by, the Addressing Scheme of the former focuses primarily on the HOST IP Address (Assignment), while the focus of the latter emphasizes only the Network IP Address. Nevertheless, it shall be concluded, the Addressing Methods used in the Schematic also affects the Efficiency; 'the RATIO of Total Number of Nodes that can be attached to Service the Global Networking Community, and the Number of available IP Addresses used for the Connection'.

In other words, this 'Analysis is Argument', whose focus upon the 'HD-Ratio' and the 'CIDR Notation' establishes the foundation defining the 'INTERNET PROTOCOL t1 and t2 ADDRESS SPACE' for the IPt1 and IPt2 Protocol Specifications. Which moreover, exceeds the Mandate Defining a New IP Addressing System specified as the Requirements outlined in RFC1550.

"This work is Dedicated to my first and only child, 'Yahnay', who is; the Mover of Dreams, the Maker of Reality, and the 'Princess of the New Universe'. (E.T.)"

Introduction: Analysis and Impact of the IPv4 Internet Protocol
Address Space, which Questions the Current Use of
and Application of the 'CIDR Notation'

The mathematical learning curve regarding an understanding of such concepts as 'Bit Mapping' the 'Network, or Host Portion of an IP Address' can be long and arduous. And this is seen especially true, when trying to grasp the 'How-To's' and functional purpose of 'CIDR'. And while I have read the works from only a few authors whose approach makes a distinction, as would be a noted difference in the interpretation of the definition of 'CIDR'. I have noted moreover, their approach is not a pronounced separation, as would be the unquestionable distinction used in the 'Water and Oil' analogy from Chemistry. However, the beginner, would understand quite clearly the difference between the 'Front-End' and 'Back-End' approaches used in "Supernetting of an IP Address". Where by the 'Bit Mapping' of the 'Network Portion', would represent the 'Front-End' approach, and the 'Bit Mapping' of the 'Host Portion' would represent the 'Back-End' approach, in what is defined, or called the "Supernetting of an IP Address", or 'CIDR'. Nevertheless, while the mathematical operation involved in either the 'Front-End' or 'Back-End' usage of 'CIDR' is not, by itself, confusing or conflicting operations. Still, a lot remains the Wishful Dream, or on the 'Wish List' of the hopeful, regarding a greater Specificity in the definition and distinction of the functional 'Parameters' associated with the conventions used in the 'CIDR' notation representing a Network IP Address. Needless to say, this becomes even more evident when trying to understand the "INTERNET PROTOCOL V4 ADDRESS SPACE", which was developed and used by IANA as a guide, or scheme, Denoting some Method used to determine IP Address Availability, Special Assignment, and Allocation.

In other words, TABLE 1, the "IPv4 Internet Protocol Address Space", according to the current standards and definition of 'CIDR', one would conclude that there is a great number of IP Addresses wasted on HOST Assignments. And this is apparent from the 'Bit Map' definition assigned to the notation "/8". Where in any 32 Bit IP Addressing format, this 'Bit Mapping' notation accounts for (Class A = 126×254^3) 2,064,770,064 IP Addresses under the current IPv4 specification, that is, without using the 'Front-End' indicator, specified number of addresses, from Class A. And then, when it is used, it would it would account, (again using the current definitions of 'CIDR') an assignment, or allocation of more than 16 Million IP Address (1×245^3). Which, to say the very least, amounts to IP Address waste, because this has the effect of providing a Host with Network Status. 'Not to mention that most of the companies, who has such an arrangement are not "IPS's"'.

Nevertheless, the Mathematical Problem(s) encompassing these definitions far out weight the problems associated with IP Address Waste. In other words, the Current Methods and Definitions of 'CIDR', regarding its use in 'Bit Mapping' an IP Address, is Mathematically Incorrect. Or just plain Wrong! In other words, an '8 Bit Mapping' Designation under the Current '32 Bit IP Specification', can only account for '255' IP Addresses (And NO more than that!). To be more specific however, what this means Mathematically, is that, there is only '1' of the '4' '8 Bit Quadrants' being used, which sets the Parameters for the Total Number of IP Addresses Assigned. Moreover, the use of only '1' Quadrant, as a means for specification regarding the total number of IP Addresses assigned, is an Error. Which can not be used to Account for the 'Diversity in Number', regarding the Total Number Combinations Derived from the Calculation of the Total Number of IP Addresses Contained in the IP Address Class.

Unfortunately however, the above argument leads to a mathematical Proof, which revives an Old Argument regarding the Method of Enumeration using the Binary Numbering System. In other words, the Total, or Inclusive Count, which would represent the '8 Bit Mapping' notation, '/8', would not yield the Binary Number '255'. It would in fact represent '256', because Zero, under the Current Binary Specification, is indeed a Binary Number (0000). Furthermore, it should be understood, that this does serve not only the explanation for the ongoing argument, but the Current Definition of the Modern Binary System as well. Which is to say, under the Current, or Modern Binary System, {11111111} = '8 Bits' = '255', does not follow from the Definition of '2', representing Base, in what is clearly (Defining the Binary Representation in the 32 Bit Addressing) an Exponential Equation, represented by the equation, 2^N . In which case, the Total, or Inclusive Count for an '8 Bit' translation of a Binary Number representing an Integer, would be given by the equation, $2^8 = 256^{**}$. This moreover, Mathematically implies the equation, $8^{32} = 256^4$, which would be interpreted as meaning; 'There are '32' Bits used to represent the '4,294,967,296' Integers, which represents the Total Number of IP Addresses contained in the IPv4 Addressing Specification. Nevertheless, while the counting methods used in the Binary System remain in Dispute, an adequate representation for the 'CIDR' Notation can be determined using the Current Binary Methods for Enumeration. That is, given by TABLE 2, we have:

**Note: In other words; {11111111} = '2 X 2 X 2 X 2 X 2 X 2 X 2 X 2 X 2'
= 256 = 2^8 ... And this is the Current or Modern Definition
using the accepted Binary System... So, Why '255'???

TABLE 1

IPv4 Internet Protocol Address Space

Address Block	Registry - Purpose	Date
000/8	IANA - Reserved	Sep 81
001/8	IANA - Reserved	Sep 81
002/8	IANA - Reserved	Sep 81
003/8	General Electric Company	May 94
004/8	Bolt Beranek and Newman Inc.	Dec 92
005/8	IANA - Reserved	Jul 95
006/8	Army Information Systems Center	Feb 94
007/8	IANA - Reserved	Apr 95
008/8	Bolt Beranek and Newman Inc.	Dec 92
009/8	IBM	Aug 92
010/8	IANA - Private Use	Jun 95
011/8	DoD Intel Information Systems	May 93
012/8	AT&T Bell Laboratories	Jun 95
013/8	Xerox Corporation	Sep 91
014/8	IANA - Public Data Network	Jun 91
015/8	Hewlett-Packard Company	Jul 94
016/8	Digital Equipment Corporation	Nov 94
017/8	Apple Computer Inc.	Jul 92
018/8	MIT	Jan 94
019/8	Ford Motor Company	May 95
020/8	Computer Sciences Corporation	Oct 94
021/8	DDN-RVN	Jul 91
022/8	Defense Information Systems Agency	May 93
023/8	IANA - Reserved	Jul 95
024/8	ARIN - Cable Block (Formerly IANA - Jul 95)	May 01
025/8	Royal Signals and Radar Establishment	Jan 95
026/8	Defense Information Systems Agency	May 95
027/8	IANA - Reserved	Apr 95
028/8	DSI-North	Jul 92
029/8	Defense Information Systems Agency	Jul 91
030/8	Defense Information Systems Agency	Jul 91
031/8	IANA - Reserved	Apr 99
032/8	Norsk Informasjonsteknologi	Jun 94
033/8	DLA Systems Automation Center	Jan 91
034/8	Halliburton Company	Mar 93
035/8	MERIT Computer Network	Apr 94
036/8	IANA - Reserved (Formerly Stanford University - Apr 93)	Jul 00

037/8	IANA - Reserved	Apr 95
038/8	Performance Systems International	Sep 94
039/8	IANA - Reserved	Apr 95
040/8	Eli Lily and Company	Jun 94
041/8	IANA - Reserved	May 95
042/8	IANA - Reserved	Jul 95
043/8	Japan Inet	Jan 91
044/8	Amateur Radio Digital Communications	Jul 92
045/8	Interop Show Network	Jan 95
046/8	Bolt Beranek and Newman Inc.	Dec 92
047/8	Bell-Northern Research	Jan 91
048/8	Prudential Securities Inc.	May 95
049/8	Joint Technical Command	May 94
	Returned to IANA	Mar 98
050/8	Joint Technical Command	May 94
	Returned to IANA	Mar 98
051/8	Department of Social Security of UK	Aug 94
052/8	E.I. duPont de Nemours and Co., Inc.	Dec 91
053/8	Cap Debis CCS	Oct 93
054/8	Merck and Co., Inc.	Mar 92
055/8	Boeing Computer Services	Apr 95
056/8	U.S. Postal Service	Jun 94
057/8	SITA	May 95
058/8	IANA - Reserved	Sep 81
059/8	IANA - Reserved	Sep 81
060/8	IANA - Reserved	Sep 81
061/8	APNIC - Pacific Rim	Apr 97
062/8	RIPE NCC - Europe	Apr 97
063/8	ARIN	Apr 97
064/8	ARIN	Jul 99
065/8	ARIN	Jul 00
066/8	ARIN	Jul 00
067/8	ARIN	May 01
068/8	ARIN	Jun 01
069-079/8	IANA - Reserved	Sep 81
080/8	RIPE NCC	Apr 01
081/8	RIPE NCC	Apr 01
082-095/8	IANA - Reserved	Sep 81
096-126/8	IANA - Reserved	Sep 81
127/8	IANA - Reserved	Sep 81
128-191/8	Various Registries	May 93

192/8	Various Registries - MultiRegional	May 93
193/8	RIPE NCC - Europe	May 93
194/8	RIPE NCC - Europe	May 93
195/8	RIPE NCC - Europe	May 93
196/8	Various Registries	May 93
197/8	IANA - Reserved	May 93
198/8	Various Registries	May 93
199/8	ARIN - North America	May 93
200/8	ARIN - Central and South America	May 93
201/8	Reserved - Central and South America	May 93
202/8	APNIC - Pacific Rim	May 93
203/8	APNIC - Pacific Rim	May 93
204/8	ARIN - North America	Mar 94
205/8	ARIN - North America	Mar 94
206/8	ARIN - North America	Apr 95
207/8	ARIN - North America	Nov 95
208/8	ARIN - North America	Apr 96
209/8	ARIN - North America	Jun 96
210/8	APNIC - Pacific Rim	Jun 96
211/8	APNIC - Pacific Rim	Jun 96
212/8	IPE NCC - Europe	Oct 97
213/8	RIPE NCC - Europe	Mar 99
214/8	US-DOD	Mar 98
215/8	US-DOD	Mar 98
216/8	ARIN - North America	Apr 98
217/8	RIPE NCC - Europe	Jun 00
218/8	APNIC - Pacific Rim	Dec 00
219/8	APNIC	Sep 01
220/8	APNIC	Dec 01
221-223/8	IANA - Reserved	Sep 81
224-239/8	IANA - Multicast	Sep 81
240-255/8	IANA - Reserved	Sep 81

TABLE 2

IPv4 'Bit Mapped' IP Address Distribution
 Derived from the Modern Method for Binary Enumeration
 Using the 'CIDR' Notation

1	2	3	4
Network IP Address Class Range /Starting Network Prefix: Number of Bits V "/New 'CIDR' Notation"	Number of IP Addresses Issued /for the Octet Representing the IP Address Class Range V	Exponential equation yielding Total Number IP Addresses Issued V	Total Number of IP Addresses Issued V

CLASS A

0-126/00:08 =	0/8 =	2 ⁰ =	1
0-126/00:08 =	1/8 =	2 ¹ =	2
0-126/00:08 =	2/8 =	2 ² =	4
	V	V	V
0-126/00:08 =	6/8 =	2 ⁶ =	64
	V	V	V
0-126/00:08 =	X/8 =	2 ^X =	126

CLASS B

128-191/10:16 =	0/16 =	2 ⁰ =	1
128-191/10:16 =	1/16 =	2 ¹ =	2
	V	V	V
128-191/10:16 =	X/16 =	2 ^X =	16,256

CLASS C

$$\begin{array}{rclclcl}
 192-223/110:24 & = & 0/24 & = & 2^0 & = & 1 \\
 192-223/110:24 & = & 1/24 & = & 2^1 & = & 2 \\
 & & | & & | & & | \\
 & & V & & V & & V \\
 192-223/110:24 & = & X/24 & = & 2^X & = & 2,064,512
 \end{array}$$

Nevertheless, while Table 2 provides a better description and use of the 'CIDR' notation, it falls extricably short from the full exploitation, and the actual representation regarding the True Value of 'CIDR'. In other words, the real Value for the use of 'CIDR', would be seen to take advantage of the Total Number of IP Addresses contained in the IPv4 specification, and not just the limited number of IP Addresses contained in 'Class C'. Where by, it should be very clear, that while Table 1 does provide an easily discernable explanation of the IP Addresses Allocated. Now. It also shows the IP Address waste, because it does nothing to change, nor fix the Loss of more than 16 Million IP Addresses, for every IP Address issued, which represents the Number IP Addresses wasted on HOST Address assignment. Nonetheless, Re-Defining the CIDR' Notation as depicting the 'Network Prefix' and the 'Bit Range it Uses', as used in Table 2, under column '1', does indeed provide the necessary foundation for its full exploitation, and establishes a smooth Transition, which is required by the 'IPtX IP Addressing Specification' (See Chapter II). Needless to say, this method clearly follows from the definition of 'CIDR', and builds upon the existing foundation, which was logically derived and used in the IPv4 specification.

Chapter I: Analysis IPv4, IPT1, and IPT2 address space using
the HD-Ratio

As shown in RFC1715, and RFC3194, the HD-ratio proved to be a Dismal Failure for use as an indicator to determine IP Address use and Distribution Efficiencies. In fact, it can easily be concluded that the IPT1 and IPT2 IP Specification are the only Addressing Protocols which meet the All of the Requirements outlined in RFC1550, especially since, they were Logically Derived from the IPv4 IP Specification. In other words, the IPT1 and IPT2 Protocol Specifications not only meet the Transitional requirements, as would be viewed as meeting all of the Engineering considerations required under RFC1550, but it also offers a more Gradual, and yet Infinite Expansion Possibilities, to meet the challenge that only the Colonization of the Universe could provide.

Needless to say, when examining the benefits of using the HD-Ratio, one would discover, that is has absolutely No application regarding the determination of the Efficiency Rating for the IPv4, IPv6, and especially not the IPT1 and IPT2 Addressing Protocol Specification(s), because these protocols makes use of more than 99.999+% of the IP Addresses contained in this Addressing System. And while some of the additional protocol definitions and specifications, which increased the benefits of the IPv4 foundation, has been remarked, or viewed as being unnecessary Growing Pains. These remarks should not be considered as being anything but unintelligent babblings. As an example, the use of 'CIDR', while not fully exploited, follows logically, from the foundation of the IPv4 Specification, and paved the way for the Mathematical and Logical derivation of a 2 New IP Addressing Systems. These Specifications moreover, Completely exploit the Solid Foundation provided by the IPv4 Specification. In other words, at best, the H-Ratio, Unlike the HD-Ratio, is a Beguilement, whose only purpose is to deceive, because surely the Logarithmic Equation described in RFC1715 could not serve any vital purpose. In which case, the author would have been better off using the elementary method for calculating the actual Efficiency Rating (see Eq. 1). Because taking the Log to the Base 10, using this equation, would not have derived any practical meaning, at least not one which could be translated into some actuate determination for some Efficiency Rating regarding the IP Addressing Systems. And this becomes even more apparent, when it is realized that the Number of Bits used to represent an IP Address does not account for the Total Number of IP Addresses available in the IP Addressing System.

Eq. 1

$$H = \frac{\log(\text{number of objects})}{\text{available bits}}$$

Furthermore, while RFC3194 provides a more accurate Logarithmic Equation for Efficiency Determination, HD-Ratio, its usage would be more applicable in a Current Use scenario (See Eq. 2). This becomes even more apparent when it is realized that the 'Numerator' used in the equation 'can' represent a 'Constant', or Specified Value, and not the result derived from some 'Sampling Related to a Statistical Analyses of the World's Population Growth or Decline Patterns.

Eq. 2

$$HD = \frac{\log(\text{number of allocated objects})}{\log(\text{maximum number of allocatable objects})}$$

Even still, suppose for a moment that Eq. 2 were a valid representation for the determination of the Efficiency Rating for an IP Addressing System. And suppose even further, that a test was needed to determine the value of the IPT1 Addressing Specification, then the results from the Calculations using this equation would be 'Startling', because the 'HD-Ratio' would approach NEARLY a VALUE of '1'. This is because all of the available IP Addresses, which are available in this IP Addressing Specification are used for Network Assignment, the point of 'Demarcation', that excludes the use of a viable Network IP Address for Host Address Assignment. Which also emphasizes the point regarding its functional use; Analysis of the Percentage of Network Addresses vs. Host, or Nodes Connected vs. Number of Available IP Addresses used for the Connection. And if you would note Table 3, and the Currently Acceptable IP Network Addressing Practices, then it would be realized, that the Entire World could Actually be Networked using only Section 'A-1' from Class A of IPT1 IP Addressing Specification.

Furthermore, since the Prefixes used in the IPT2 IP Protocol Specification can not be used in any calculation, which would be required for the Determination of the Efficiency Rating regarding the use of the Total Number of IP Address. Then their use within the IPT2 Protocol Specification is indeed an Enhancement, which can only be viewed as a Magnification Freebie. That is, without question, IPT2 allows a more Gradual Growth that can quite easily be Expanded to Infinity (See Tables 4 and 5). In which case, Population Growth really does not matter, because it is now a Variable that has been removed from the Equation.

Nevertheless, while there was some mention of a comparison to other Addressing Systems, there was No mention regarding the way these Numbering Systems were used or even Allocated (i.e. The telephony System). In other words, their mention was pointless, because no clear foundation, that could be viewed as having establish the Point upon which an Argument could be based was ever mentioned or shown to exist. In a word; 'I actually did not understand the point, nor purpose of either RFC1715 nor RFC3194, because it seems that these RFCs were focused more upon the Logarithmic Equation, rather than the reported objective regarding the Efficiency Rating, and the Determination of the most efficient IP Addressing scheme that should be used. And clearly, if a Viable Network Connection, Network IP Address, is used for Host Address Assignment, which is behind the Demarcation Line, then this is a Waste that would affect the Calculation of Efficiency. Furthermore, while I have read some mention regarding the 'Address Space Allocation Table(s), it was never pointed out, that the 'Address Allocation Table' (Or "INTERNET PROTOCOL ADDRESS SPACE") could quite literally invalidate any calculation regarding efficiency, because such a TABLE can also be INEFFICIENT.

Table 3

"Reality of the Mathematical Addressing Schematic for the 'IPt1' Addressing System Using the Modern Binary System."
(Where the Value for the variable 'Y' is given by the Laws of the Octet, and the System contains 4.145×10^9 Addresses.)

1. Total IP Addresses for Class A = $126 \times 254^3 = 2,064,770,064$
Total available IP Addresses for Class A = 126×254^3
Total available IP Host Addresses Equals 126×254^N
(Where N = Number of Octet, and 'Y' equals the Address Range '128 - 254', 1 - 126 is not included in the Address Range Represented by the equation 'Y = 254 - 126'.)

Class A-1, 1 - 126, Default Subnet Mask 255.y.x.x:
1,040,514,048 Networks and 8,129,016 Hosts: /00:08

Class A-2, 1 - 126, Default Subnet Mask 255.255.y.x:
516,160,512 Networks and 32,004 Hosts: /00:16

Class A-3, 1 - 126, Default Subnet Mask 255.255.255.y:
256,048,128 Networks and 126 Hosts: /00:24

Class A-4, 1 - 126, Default Subnet Mask 255.255.255.255:
252,047,376 Network / MultiCast IP Addresses / AnyCast: /00:32

2. Total IP Addresses for Class B = $64 \times 254^3 = 1,048,772,096$
Total available IP Addresses for Class B = 64×254^3
Total available IP Host Addresses Equals 64×254^N
(Where N = Number of Octet, and 'Y' equals the Address Range '254 - Q'; 128 - 191 is not included in the Address Range Represented by the equation 'Y = 254 - 64'.)

Class B-1, 128 - 191, Default Subnet Mask 255.y.x.x:
784,514,560 Networks and 4,129,024 Hosts: /10:08

Class B-2, 128 - 191, Default Subnet Mask 255.255.y.x:
197,672,960 Networks and 16,256 Hosts: /10:16

Class B-3, 128 - 191, Default Subnet Mask 255.255.255.y:
49,807,360 Networks and 64 Hosts: /10:24

Class B-4, 128 - 191, Default Subnet Mask 255.255.255.255:
16,777,216 Network / MultiCast IP Addresses / AnyCast: /10:32

3. Total IP Addresses for Class C = $32 \times 254^3 = 524,386,048$
Total available IP Addresses for Class C = 32×254^3
Total available IP Host Addresses Equals 32×254^N
(Where N = Number of Octet, and 'Y' equals the Address
Range '254 - Q'; 192 - 223 is not included in the
Address Range Represented by the equation
'Y = 254 - 32'.)

Class C-1, 192 - 223, Default Subnet Mask 255.y.x.x:
458,321,664 Networks and 2,064,512 Hosts: /110:08

Class C-2, 192 - 223, Default Subnet Mask 255.255.y.x:
57,741,312 Networks and 8,128 Hosts: /110:16

Class C-3, 192 - 223, Default Subnet Mask 255.255.255.y:
7,274,496 Networks and 32 Hosts: /110:24

Class C-4, 192 - 223, Default Subnet Mask 255.255.255.255:
1,048,576 Network / MultiCast IP Addresses / AnyCast: /110:32

4. Total IP Addresses for Class D = $16 \times 254^3 = 262,193,024$
Total available IP Addresses for Class D = 16×254^3
Total available IP Host Addresses Equals 16×254^N
(Where N = Number of Octet, and 'Y' equals the Address
Range '254 - Q'; 224 - 239 is not included in the
Address Range Represented by the equation
'Y = 254 - 16'.)

Class D-1, 224 - 239, Default Subnet Mask 255.y.x.x:
245,676,928 Networks and 1,032,256 Hosts: /1110:08

Class D-2, 224 - 239, Default Subnet Mask 255.255.y.x:
15,475,712 Networks and 4,064 Hosts: /1110:16

Class D-3, 224 - 239, Default Subnet Mask 255.255.255.y:
974,848 Networks and 16 Hosts: /1110:24

Class D-4, 224 - 239, Default Subnet Mask 255.255.255.255:
65,536 Network / MultiCast IP Addresses / AnyCast: /1110:32

5. Total IP Addresses for Class E = $15 \times 254^3 = 245,805,960$
 Total available IP Addresses for Class E = 15×254^3
 Total available IP Host Addresses Equals 15×254^N
 (Where N = Number of Octet, and 'Y' equals the Address
 Range '254 - Q'; 240 - 254 is not included in the
 Address Range Represented by the equation
 'Y = 254 - 15'.)

Class E-1, 240 - 254, Default Subnet Mask 255.y.x.x:
 231,289,860 Networks and 967,740 Hosts: /1111:08

Class E-2, 240 - 254, Default Subnet Mask 255.255.y.x:
 13,658,850 Networks and 3,810 Hosts: /1111:16

Class E-3, 240 - 254, Default Subnet Mask 255.255.255.y:
 806,625 Networks and 15 Hosts: /1111:24

Class E-4, 240 - 254, Default Subnet Mask 255.255.255.255:
 50,625 Network / MultiCast IP Addresses / AnyCast: /1111:32

Table 4

Reality of the Structure of the
 Addressing Schematic Design for the IPT2
 Protocol Specification Using The Modern Binary System
 Which yields a Combined Total
 of 2.67×10^{14} IP Addresses

'254' Total Zone IP Addresses v	'254' IP Area Code Addresses per 'Zone IP' Address v	One Copy Of 'IPT1' Addressing Schematic per 'IP Area Code Address' = 253×254^3 IP Addresses v	'CIDR' Network Descriptor v
Zone IP	IP Area Code	IP Address	
+-----+-----+-----+-----+			
... 255	:	255	:
		255.000.000.000	/XXXX:XX
v	v	v	v
<-Global-Net	InterNet	IntraNet	

Table 5

"Reality of the Structure of the Schematic for the 'IPt2' IP Specification Using the Modern Binary System."(Where the Value for the variable 'Y' is given by the Laws of the Octet, and Total Number of Available IP Addresses Equals 2.67×10^{14} .)

1. Total IP Addresses for 'Class A' having '254' 'Zone IP' Addresses

$$\begin{aligned} &= 254 \times 254 \times 126 \times 254^3 \\ &= 254 \times 254 \times 2,064,770,064 \\ &= 1.332107 \times 10^{14} \end{aligned}$$

Total of 254 IP 'IP Area Code' Addresses per 'Zone IP' Address

$$\begin{aligned} &= 254 \times 126 \times 254^3 \\ &= 254 \times 2,064,770,064 \\ &= 5.244516 \times 10^{11} \end{aligned}$$

Distribution per 'Zone IP' Address yielding the 'IP Area Code' Addresses

Class A-1, 1 - 126, Default Subnet Mask 255.y.x.x:
2.642906 x 10^{11} Networks and 8,129,016 Hosts: /00:08

Class A-2, 1 - 126, Default Subnet Mask 255.255.y.x:
1.311048 x 10^{11} Networks and 32,004 Hosts: /00:16

Class A-3, 1 - 126, Default Subnet Mask 255.255.255.y:
6.503622 x 10^{10} Networks and 126 Hosts: /00:24

Class A-4, 1 - 126, Default Subnet Mask 255.255.255.255:
6.4020034 x 10^{10} Network / MultiCast IP Addresses / AnyCast: /00:32

2. Total IP Addresses for 'Class B' having '254' 'Zone IP' Addresses

$$\begin{aligned} &= 254 \times 254 \times 64 \times 254^3 \\ &= 254 \times 254 \times 1,048,772,096 \\ &= 6.766258 \times 10^{13} \end{aligned}$$

Total of 254 IP 'IP Area Code' Addresses per 'Zone IP' Address

$$\begin{aligned} &= 254 \times 64 \times 254^3 \\ &= 254 \times 1,048,772,096 \\ &= 2.663881 \times 10^{11} \end{aligned}$$

Distribution per 'Zone IP' Address yielding the 'IP Area Code' Addresses

Class B-1, 128 - 191, Default Subnet Mask 255.y.x.x:
1.992667 x 10¹¹ Networks and 4,129,024 Hosts: /10:08

Class B-2, 128 - 191, Default Subnet Mask 255.255.y.x:
5.0208932 x 10¹⁰ Networks and 16,256 Hosts: /10:16

Class B-3, 128 - 191, Default Subnet Mask 255.255.255.y:
1.2651069 x 10¹⁰ Networks and 64 Hosts: /10:24

Class B-4, 128 - 191, Default Subnet Mask 255.255.255.255:
4.2614129 x 10⁹ Network / MultiCast IP Addresses / AnyCast: /10:32

3. Total IP Addresses for 'Class C' having '254' 'Zone IP' Addresses

$$\begin{aligned} &= 254 \times 254 \times 32 \times 254^3 \\ &= 254 \times 254 \times 524,386,048 \\ &= 3.383129 \times 10^{13} \end{aligned}$$

Total of 254 IP 'IP Area Code' Addresses per 'Zone IP' Address

$$\begin{aligned} &= 254 \times 32 \times 256^3 \\ &= 254 \times 524,386,048 \\ &= 1.331941 \times 10^{11} \end{aligned}$$

Distribution per 'Zone IP' Address yielding the 'IP Area Code' Addresses

Class C-1, 192 - 223, Default Subnet Mask 255.y.x.x:
1.164137 x 10¹¹ Networks and 2,064,512 Hosts: /110:08

Class C-2, 192 - 223, Default Subnet Mask 255.255.y.x:
1.466629 x 10¹⁰ Networks and 8,128 Hosts: /110:16

Class C-3, 192 - 223, Default Subnet Mask 255.255.255.y:
1.8477220 x 10⁹ Networks and 32 Hosts: /110:24

Class C-4, 192 - 223, Default Subnet Mask 255.255.255.255:
2.663383 x 10⁸ Network / MultiCast IP Addresses / AnyCast: /110:32

4. Total IP Addresses for 'Class D' having '254' 'Zone IP' Addresses

$$\begin{aligned} &= 254 \times 254 \times 16 \times 254^3 \\ &= 254 \times 254 \times 262,193,024 \\ &= 1.691558 \times 10^{13} \end{aligned}$$

Total of 254 IP 'IP Area Code' Addresses per 'Zone IP' Address

$$\begin{aligned} &= 254 \times 16 \times 254^3 \\ &= 254 \times 262,193,024 \\ &= 6.659677 \times 10^{10} \end{aligned}$$

Distribution per 'Zone IP' Address yielding the 'IP Area Code' Addresses

Class D-1, 224 - 239, Default Subnet Mask 255.y.x.x:
6.240194 x 10¹⁰ Networks and 1,032,256 Hosts: /1110:08

Class D-2, 224 - 239, Default Subnet Mask 255.255.y.x:
3.930831 x 10⁹ Networks and 4,064 Hosts: /1110:16

Class D-3, 224 - 239, Default Subnet Mask 255.255.255.y:
2.476114 x 10⁸ Networks and 16 Hosts: /1110:24

Class D-4, 224 - 239, Default Subnet Mask 255.255.255.255:
1.6646144 x 10⁷ Network / MultiCast IP Addresses / AnyCast: /1110:32

5. Total IP Addresses for 'Class E' having '254' 'Zone IP' Addresses

$$\begin{aligned} &= 254 \times 254 \times 15 \times 254^3 \\ &= 254 \times 254 \times 245,805,960 \\ &= 1.585842 \times 10^{13} \end{aligned}$$

Total of 254 IP 'IP Area Code' Addresses per 'Zone IP' Address

$$\begin{aligned} &= 254 \times 15 \times 254^3 \\ &= 254 \times 245,805,960 \\ &= 6.243471 \times 10^{10} \end{aligned}$$

Distribution per 'Zone IP' Address yielding the 'IP Area Code' Addresses

Class E-1, 240 - 254, Default Subnet Mask 255.y.x.x:
5.874762 x 10¹⁰ Networks and 967,740 Hosts: /1111:08

Class E-2, 240 - 254, Default Subnet Mask 255.255.y.x:
3.4693479 x 10⁹ Networks and 3,810 Hosts: /1111:16

Class E-3, 240 - 254, Default Subnet Mask 255.255.255.y:
2.0488275 x 10⁸ Networks and 15 Hosts: /1111:24

Class E-4, 240 - 254, Default Subnet Mask 255.255.255.255:
1.285875 x 10⁷ Network / MultiCast IP Addresses / AnyCast: /1111:32

Chapter II: Suggestion for the IPT1 and IPT2 Internet Protocol Address Space, Supernetting and the New 'CIDR' Notation

The "Internet Protocol v4 Address Space" allocation Table, as noted in 'Table 1' above, can retain the same IP Address Allocation, in the 'IPT1 IP Protocol Specification'. In fact, the only guidelines that would be different, and appropriated, are those governing the 'Host' Address Allocation, whose distribution is Defined by 'The Laws of the Octet'. Furthermore, noting Table 2, it should be understood that it represents an 'IP Address Allocation / Translation Guide', which would be used to determine the total Number of Available IP Addresses when converting from the IPv4 to the IPT1 Addressing Specifications. This Table represents the IP Address conversion, which should be viewed as extremely important, because the IPT1 Specification makes use of nearly all of the total number of IP Addresses for use as the Network IP Address. And while there are Host Addresses Assigned, there are No Viable network IP Addresses wasted or used for this purpose (See The Laws of the Octet.).

Nevertheless, the description shown in Table 6 provides an Example, which describes the 'Supernetting of an IP Address' when using the 'IPT1' specification, which also uses the New Notation for 'CIDR'. However, this is a Practice, 'Supernetting of an IP Address', that can only be used BEHIND the 'Point of Demarcation' (The 'VIABLE Network IP Address'), for the purpose of Subnet / Host creation. Because to do so otherwise would not only be in violation of 'The Laws of the Octet', but it would create an Addressing Conflict within the IP Addressing Scheme itself. Even still, is should nevertheless be very clear, that the 'CIDR' Notation represents the 'Bit Mapped Displacement' of the Network IP Address, and nothing more.

Moreover, since the IPT1 specification uses the same IP Addressing methods for enumeration, as used in IPv4. It can quite easily be employed, and replace, in every scenario now occupied and used by the IPv4 Specification. There is an exception however, which translates into recovery of wasted IP Addresses that can be recovered from the "Internet Protocol v4 Address Space". In other words, as previously mentioned, the primary difference between these IP Specifications, beyond the Schematic itself, is the way they each use and assign 'Host IP Addresses'. Where by, the assignment of '1' IP Address, is just that, because there are No 16 Million Host IP Addresses that will accompany this assignment under the IPT1 specification (See Appendix I). And while this may be viewed as a problem with the IPT1 specification, it certainly does not become a consideration for the implementation of the IPT2 Addressing Specification. In fact, the IPT2 Addressing Specification not only provides foundation for the possibility for Unlimited IP Addresses, it simplifies the "Internet Protocol Address Space" Table, (See Table 7) while reducing the Management Burden associated with the Allocation of IP Addresses.

TABLE 6

IPT1 'Bit Mapped' IP Address Distribution
 Derived from the Modern Method for Binary Enumeration
 Using the 'CIDR' Notation

1	2	3	4
Network IP Address Class Range /Starting Point of the Network Prefix: Number of Bits V "/New 'CIDR' Notation"	Number of BITS V	Exponential equation yielding Total Number IP HOST IP Addresses V	Total Number of HOST IP Addresses V

CLASS A

Class A-1

$$0-126/00:08 = 8/8 = 2^X = 8,129,016$$

Class A-2

$$0-126/00:16 = 16/8 = 2^X = 32,004$$

Class A-3

$$0-126/00:24 = 24/8 = 2^X = 126$$

Class A-4

$$0-126/00:25 = 25/8 = 2^7 = 128$$

$$\begin{array}{ccccccc} & & | & & | & & | \\ & & \vee & & \vee & & \vee \\ 0-126/00:30 & = & 30/8 & = & 2^2 & = & 4 \end{array}$$

$$0-126/00:31 = 31/8 = 2^1 = 2$$

$$0-126/00:32 = 32/8 = 2^0 = 0^*$$

CLASS B

Class B-1

$$0-126/10:08 = 8/16 = 2^X = 4,129,024$$

Class B-2

$$128-191/10:16 = 16/16 = 2^X = 16,256$$

Class B-3

$$128-191/10:24 = 24/16 = 2^X = 32$$

Class B-4

128-191/10:25	=	25/16	=	2 ⁷	=	128
		v		v		v
128-191/10:30	=	30/16	=	2 ⁴	=	4
128-191/10:31	=	31/16	=	2 ¹	=	2
128-191/10:32	=	32/16	=	2 ⁰	=	0*

CLASS C

Class C-1

$$192-223/110:08 = 8/24 = 2^X = 2,064,512$$

Class C-2

$$192-223/110:16 = 16/24 = 2^X = 8,128$$

Class C-3

$$192-223/110:24 = 24/24 = 2^X = 32$$

Class C-4

$$\begin{array}{rclclcl} 0-126/110:25 & = & 25/24 & = & 2^7 & = & 128 \\ & & | & & | & & | \\ & & \vee & & \vee & & \vee \\ 0-126/110:30 & = & 30/24 & = & 2^2 & = & 4 \\ \\ 0-126/110:31 & = & 31/24 & = & 2^1 & = & 2 \\ \\ 0-126/110:32 & = & 32/24 & = & 2^0 & = & 0^* \end{array}$$

CLASS D

Class D-1

$$224-239/1110:08 = 8/28 = 2^X = 1,032,256$$

Class D-2

$$224-239/1110:16 = 16/28 = 2^X = 4,064$$

Class D-3

$$224-239/1110:24 = 24/28 = 2^X = 16$$

Class D-4

$$224-239/1110:25 = 25/28 = 2^7 = 128$$

$$\begin{array}{ccccccc} & & & | & & & | \\ & & & V & & & V \\ 224-239/1110:30 & = & 30/28 & = & 2^2 & = & 4 \end{array}$$

$$224-239/1110:31 = 31/28 = 2^1 = 2$$

$$224-239/1110:32 = 32/28 = 2^0 = 0^*$$

CLASS E

Class E-1

$$240-254/1111:08 = 8/~29 = 2^X = 967,740$$

Class E-2

$$240-254/1111:16 = 16/\sim 29 = 2^X = 3,810$$

Class E-3

$$240-254/1111:24 = 24/\sim 29 = 2^X = 15$$

Class E-4

$$\begin{array}{rclclcl} 240-254/1111:25 & = & 25/\sim 29 & = & 2^7 & = & 128 \\ & & | & & | & & | \\ & & V & & V & & V \\ 240-254/1111:30 & = & 30/\sim 29 & = & 2^2 & = & 4 \\ \\ 240-254/1111:31 & = & 31/\sim 29 & = & 2^1 & = & 2 \\ \\ 240-254/1111:32 & = & 32/\sim 29 & = & 2^0 & = & 0* \end{array}$$

*Note: Using the Current or Modern Method for Binary Enumeration, the solution here, regarding the Supernetting function and 'CIDR', is the Correct answer. However, under the New Binary System, the solution would be; $2^0 = 1$, and this would be True because, 'In the New Binary System: When considering the Network IP Address, it must be realized that Not All of the 32 Bit range of the IP Address is used in the Address Class range when dealing with a '32 Bit Mapped IP Address Space', as in /00:32. Still, if the Subnet IP = 126.126.126.126, then the Host IP Address could equal 126.126.126.127; or respectively 254.254.254.254 and 254.254.254.253. In which case, it should be realized, by definition, that '255' and '000' can not be used.

Table 7

INTERNET PROTOCOL t2 (64 Bit) ADDRESS SPACE

Reserved BITS		IPT2 IP Address / CIDR Network / \ Descriptor		Prefix Zone IP IP Area Code		IPT1 Address /Schematic\ IP Address Assignment		Distribution /Purpose\ V		Date / \ V	
8	8	None		000:	000:	000.000.000.000		None		4/2002	
8	8	All		001:	All:	XXX.XXX.XXX.XXX		NA		4/2002	
8	8	All		002:	All:	XXX.XXX.XXX.XXX		SA		4/2002	
8	8	All		003:	All:	XXX.XXX.XXX.XXX		EU		4/2002	
8	8	All		004:	All:	XXX.XXX.XXX.XXX		OS		4/2002	
8	8	All		005:	All:	XXX.XXX.XXX.XXX		AU		4/2002	
8	8	All		006:	All:	XXX.XXX.XXX.XXX		AF		4/2002	
8	8	All	007-254:		All:	XXX.XXX.XXX.XXX		IANA/RESERVED		4/2002	
8	8	All	001-254:	000-254:		000.000.000.000		IANA/EMERGENCY		4/2002	
8	8	/00:08		255:	255:	127.000.000.000		IANA/LoopBack		4/2002	

Ipt2 64 Bit Mapped Address Space

Prefix Address <----> (Or Trunk Identifier)					CIDR Network Descriptor	
8 Bits	8 Bits	8 Bits	8 Bits	32 Bit IPT1 Address Space		
Reserved:	Reserved:	Zone IP:	IP Area Code:	XXX.XXX.XXX.XXX	/XXXX:XX	

INTERNET PROTOCOL t2 ADDRESS SPACE INDEX

CONTIENTS /ZONE IP\	COUNTRIES / \	IP AREA CODE DISTRIBUTION / \	DATE / \	COMMENTS / \
'NA'	'3'	'60'	4/2002	NONE
NORTH AMERICA 001:	UNITED STATES	'001 - 050:'	4/2002	NONE
	MEXICO	'051 - 054:'	4/2002	NONE
IP AREA CODE CONTIENT SURPLUS '194'	CANADA	'055 - 060:'	4/2002	NONE
'SA'	'38'	'88'	4/2002	NONE
SOUTH AMERICA 002:	Brazil	'001 - 050:'	4/2002	NONE
IP AREA CODE CONTIENT SURPLUS '166'	Antigua and Barbuda	'051 - 052:'	4/2002	NONE
	Aruba	'053:'	4/2002	NONE
	Bahamas	'054:'	4/2002	NONE
	Barbados	'055:'	4/2002	NONE
	Cayman Islands	'056:'	4/2002	NONE
	Cuba	'057:'	4/2002	NONE
	Dominica	'058:'	4/2002	NONE
	Dominican Republic	'059:'	4/2002	NONE
	Grenada	'060:'	4/2002	NONE
	Guadeloupe	'061:'	4/2002	NONE
	Jamaica	'062:'	4/2002	NONE
	Haiti	'063:'	4/2002	NONE
	Martinique	'064:'	4/2002	NONE

Puerto Rico	'065:'	4/2002	NONE
Saint Kitts and Nevis	'066:'	4/2002	NONE
Saint Lucia	'067:'	4/2002	NONE
Trinidad and Tobago	'068:'	4/2002	NONE
Virgin Islands	'069:'	4/2002	NONE
Belize	'070:'	4/2002	NONE
Costa Rica	'071:'	4/2002	NONE
El Salvador	'072:'	4/2002	NONE
Guatemala	'073:'	4/2002	NONE
Honduras	'074:'	4/2002	NONE
Nicaragua	'075:'	4/2002	NONE
Panama	'076:'	4/2002	NONE
Argentina	'077:'	4/2002	NONE
Bolivia	'078:'	4/2002	NONE
Chile	'079:'	4/2002	NONE
Colombia	'080:'	4/2002	NONE
Ecuador	'081:'	4/2002	NONE
French Guiana	'082:'	4/2002	NONE
Guyana	'083:'	4/2002	NONE
Paraguay	'084:'	4/2002	NONE

	Peru	'085:'	4/2002	NONE
	Suriname	'086:'	4/2002	NONE
	Uruguay	'087:'	4/2002	NONE
	Venezuela	'088:'	4/2002	NONE
'EU'	'45'	'74'	4/2002	NONE
EUROPE	Belarus	'001'	4/2002	NONE
003:	Russian Federation	'002 - 031:'	4/2002	NONE
IP AREA CODE	Bulgaria	'032:'	4/2002	NONE
CONTIENT	Czech Republic	'033:'	4/2002	NONE
SURPLUS	Hungary	'034:'	4/2002	NONE
'180'	Moldova	'035:'	4/2002	NONE
	Poland	'036:'	4/2002	NONE
	Romania	'037:'	4/2002	NONE
	Slovakia	'038:'	4/2002	NONE
	Ukraine	'039:'	4/2002	NONE
	Denmark	'040:'	4/2002	NONE
	Estonia	'041:'	4/2002	NONE
	Faeroe Islands	'042:'	4/2002	NONE
	Finland	'043:'	4/2002	NONE
	Iceland	'044:'	4/2002	NONE
	Ireland	'045:'	4/2002	NONE

Latvia	'046:'	4/2002	NONE
Lithuania	'047:'	4/2002	NONE
Norway	'048:'	4/2002	NONE
Sweden	'049:'	4/2002	NONE
United Kingdom	'050:'	4/2002	NONE
Albania	'051:'	4/2002	NONE
Andorra	'052:'	4/2002	NONE
Bosnia and Herzegowina	'053:'	4/2002	NONE
Croatia (Hrvatska)	'054:'	4/2002	NONE
Gibraltar	'055:'	4/2002	NONE
Greece	'056:'	4/2002	NONE
Vatican City State	'057:'	4/2002	NONE
Italy	'058:'	4/2002	NONE
Macedonia	'059:'	4/2002	NONE
Malta	'060:'	4/2002	NONE
Portugal	'061:'	4/2002	NONE
San Marino	'062:'	4/2002	NONE
Slovenia	'063:'	4/2002	NONE
Spain	'064:'	4/2002	NONE
Yugoslavia	'065:'	4/2002	NONE
Austria	'066:'	4/2002	NONE
Belgium	'067:'	4/2002	NONE
France	'068:'	4/2002	NONE

	Germany	'069:'	4/2002	NONE
	Liechtenstein	'070:'	4/2002	NONE
	Luxembourg	'071:'	4/2002	NONE
	Monaco	'072:'	4/2002	NONE
	Netherlands	'073:'	4/2002	NONE
	Switzerland	'074:'	4/2002	NONE
	'23'	'23'	4/2002	NONE
'OS'				
OCEANIA				
STATES	Australia	'001:'	4/2002	NONE
004:	Wallis	'002:'	4/2002	NONE
IP AREA CODE	and Futuna Islands			
CONTIENT	New Zealand	'003:'	4/2002	NONE
SURPLUS	Fiji	'004:'	4/2002	NONE
'231'	Papua New Guinea	'005:'	4/2002	NONE
	New Caledonia	'006:'	4/2002	NONE
	Solomon Islands	'007:'	4/2002	NONE
	Vanuatu	'008:'	4/2002	NONE
	Guam	'009:'	4/2002	NONE
	Kiribati	'010:'	4/2002	NONE
	Marshall Islands	'011:'	4/2002	NONE
	Micronesia	'012:'	4/2002	NONE
	Nauru	'013:'	4/2002	NONE
	Palau	'014:'	4/2002	NONE

	American Samoa	'015:'	4/2002	NONE
	Northern Mariana Islands	'016:'	4/2002	NONE
	Cook Islands	'017:'	4/2002	NONE
	French Polynesia (Tahiti)	'018:'	4/2002	NONE
	Niue	'019:'	4/2002	NONE
	Pitcairn	'020:'	4/2002	NONE
	Samoa	'021:'	4/2002	NONE
	Tonga	'022:'	4/2002	NONE
	Tuvalu	'023:'	4/2002	NONE
'AU'	'55'	'55'	4/2002	NONE
AFRICAN UNION	Burundi	'001'	4/2002	NONE
005:	Democratic Republic of the Congo	'002:'	4/2002	NONE
IP AREA CODE	Djibouti	'003:'	4/2002	NONE
CONTIENT	Eritrea	'004:'	4/2002	NONE
SURPLUS	Ethiopia	'005:'	4/2002	NONE
'199'	Kenya	'006:'	4/2002	NONE
	Madagascar	'007:'	4/2002	NONE
	Malawi	'008:'	4/2002	NONE
	Mauritania	'009:'	4/2002	NONE
	Mozambique	'010:'	4/2002	NONE

Réunion	'011:'	4/2002	NONE
Rwanda	'012:'	4/2002	NONE
Seychelles	'013:'	4/2002	NONE
Somalia	'014:'	4/2002	NONE
Tanzania	'015:'	4/2002	NONE
Uganda	'016:'	4/2002	NONE
Zambia	'017:'	4/2002	NONE
Zimbabwe	'018:'	4/2002	NONE
Angola	'019:'	4/2002	NONE
Cameroon	'020:'	4/2002	NONE
Chad	'021:'	4/2002	NONE
Congo	'022:'	4/2002	NONE
Equatorial Guinea	'023:'	4/2002	NONE
Central African Republic	'024:'	4/2002	NONE
Gabon	'025:'	4/2002	NONE
Sao Tome and Principe	'026:'	4/2002	NONE
Algeria	'027:'	4/2002	NONE
Egypt	'028:'	4/2002	NONE
Libyan Arab Jamahiriya	'029:'	4/2002	NONE
Morocco	'030:'	4/2002	NONE
Sudan	'031:'	4/2002	NONE
Tunisia	'032:'	4/2002	NONE

Western Sahara	'033:'	4/2002	NONE
Botswana	'034:'	4/2002	NONE
Lesotho	'035:'	4/2002	NONE
Namibia	'036:'	4/2002	NONE
South Africa	'037:'	4/2002	NONE
Swaziland	'038:'	4/2002	NONE
Benin	'039:'	4/2002	NONE
Burkina Faso	'040:'	4/2002	NONE
Cape Verde	'041:'	4/2002	NONE
Côte d'Ivoire	'042:'	4/2002	NONE
Gambia, The	'043:'	4/2002	NONE
Ghana	'044:'	4/2002	NONE
Guinea	'045:'	4/2002	NONE
Guinea-Bissau	'046:'	4/2002	NONE
Liberia	'047:'	4/2002	NONE
Mali	'048:'	4/2002	NONE
Mauritania	'049:'	4/2002	NONE
Niger	'050:'	4/2002	NONE
Nigeria	'051:'	4/2002	NONE
Saint Helena	'052:'	4/2002	NONE
Senegal	'053:'	4/2002	NONE
Sierra Leone	'054:'	4/2002	NONE
Togo	'055:'	4/2002	NONE

'AF'	'55'	'151'	4/2002	NONE
ASIAN FEDERATION 006:	China	'001-051'	4/2002	NONE
IP AREA CODE	Japan	'052:'	4/2002	NONE
CONTIENT	Korea (North)	'053:'	4/2002	NONE
SURPLUS '103'	Korea (South)	'054:'	4/2002	NONE
	Macau	'055:'	4/2002	NONE
	Mongolia	'056:'	4/2002	NONE
	Taiwan	'057:'	4/2002	NONE
	Afghanistan	'058:'	4/2002	NONE
	Bangladesh	'059:'	4/2002	NONE
	Bhutan	'060:'	4/2002	NONE
	India	'061-111'	4/2002	NONE
	Iran	'112:'	4/2002	NONE
	Kazakhstan	'113:'	4/2002	NONE
	Kyrgyzstan	'114:'	4/2002	NONE
	Maldives	'115:'	4/2002	NONE
	Nepal	'116:'	4/2002	NONE
	Pakistan	'117:'	4/2002	NONE
	Sri Lanka	'118:'	4/2002	NONE
	Tajikistan	'119:'	4/2002	NONE
	Turkmenistan	'120:'	4/2002	NONE

Uzbekistan	'121:'	4/2002	NONE
Brunei Darussalam	'122:'	4/2002	NONE
Cambodia	'123:'	4/2002	NONE
East Timor	'124:'	4/2002	NONE
Indonesia	'125:'	4/2002	NONE
Laos	'126:'	4/2002	NONE
Malaysia	'127:'	4/2002	NONE
Myanmar (Burma)	'128:'	4/2002	NONE
Philippines	'129:'	4/2002	NONE
Singapore	'130:'	4/2002	NONE
Thailand	'131:'	4/2002	NONE
Viet Nam	'132:'	4/2002	NONE
Armenia	'133:'	4/2002	NONE
Azerbaijan	'134:'	4/2002	NONE
Bahrain	'135:'	4/2002	NONE
Cyprus	'136:'	4/2002	NONE
Georgia	'137:'	4/2002	NONE
Iraq	'138:'	4/2002	NONE
Israel	'139:'	4/2002	NONE
Jordan	'140:'	4/2002	NONE
Kuwait	'141:'	4/2002	NONE
Lebanon	'142:'	4/2002	NONE
Gambia, The	'143:'	4/2002	NONE

Oman	'144:'	4/2002	NONE
Qatar	'145:'	4/2002	NONE
Palestine	'146:'	4/2002	NONE
Saudi Arabia	'147:'	4/2002	NONE
Syria	'148:'	4/2002	NONE
Turkey	'149:'	4/2002	NONE
United Arab Emirates	'150:'	4/2002	NONE
Yemen	'151:'	4/2002	NONE

Nevertheless, any careful examination and study of Table 7, the "INTERNET PROTOCOL t2 ADDRESS SPACE", and its INDEX. Anyone would readily conclude; 'It does not matter if the World's Population Doubled or Tripled in 5, 10, or 15 years from now, because the number of IP Addresses contained in the Surplus of IP Area Code Addresses, for each Continent, would presently sustain a 20 Billion total World Population, and this says nothing about the Reserve IP Addresses allocation to IANA. In fact, if there is an agreement (which it will be) regarding the New Binary System, it will not pose any difficulties for IANA, because these IP Specifications were derived and first discovered, using the New Method of Enumeration, as defined by the New Binary System. In other words, the IPT1 and IPT2 IP Protocol Specifications overwhelmingly surpasses every Requirement Specified in RFC1550.

It has been mention that the IPT1 IP Specification differs only in 2 primary areas from that of the IPv4 IP Addressing system. And these differences account for the use of more than 99.999...+ % of the total number of available IP Addresses contained in this System of Addressing, and the way Host IP Addresses are allocated. Needless to say, other than the Schematic itself, that's it. In other words, the use of 'APRA and IN-ADD.APRA functions the same in the IPT1 IP Specification, and except for the 'SIGHT' of the Prefixes used in the IPT2 Specification, their use functions the same under this IP Specification as well. In other words, the Prefixes used in the IPT2 IP Specification, serve only the provisions regarding stability, control, management, and increase the Number of IP Addresses (And nothing more!). Because other than these benefits, the Prefixes used in the IPT2 IP Specification does absolutely nothing to effect, nor change any other the practices or procedures used in the IPv4 Protocol. Furthermore, while I do not advocate the used of the Primary IP Protocol in Networking Household Appliances, (behind the demarcation). It should be clearly understood, not only is the IPT2 IP Specification well suited for this application, but there is absolutely No Protocol Requirement, or Demand, it is not suited to address...And it goes without saying, it does indeed, maintain a sufficient supply of IP Addresses, regardless (The 'IPTX' IP Specification: See Table 8, and Appendix II).

Table 8

'IPTX IP Specification'
(Topology of Internet Backbone Without Hierarchy)

Addressing Specification		Header BITS Size Specification
IPT1	=	32 Bit
IPT2	=	64 Bit
IPT3	=	96 Bit
IPT4	=	128 Bit
IPT5	=	160 Bit
:	:	:
IPT100	=	3,200 Bit
:	:	:
IPT5000	=	160,000 Bit
:	:	:
IPTX	=	Infinity

Chapter IV: Security

This document, whose only objective was the explanation for the method(s) used in the Efficiency Determination of an IP Addressing Specification, and the development of a possible (Suggestion) "INTERNET PROTOCOL ADDRESS SPACE" for the 'IPt1 and IPt2 IP Addressing Specifications', which actually did not directly raise any security issues. Hence, there are no issues raised that warrant Security Considerations.



Figure 1-A; Visualizing the 'Zone IP' and 'IP Area Code' Addresses



Figure 2-A: 'NA' Continent; Zone IP Address = '001' (See Table 7)



**Figure 3-A: Different 'IP Area Code' Address for each State
(See the Index of Table 7)**

Appendix I: IPT1 Internet Protocol Address Space

TABLE 9

Internet Protocol t1 Address Space
 Compatibility / Conversion with the
 Internet Protocol v4 Address Space

Address Block	Registry - Purpose	Date
Number of IP Addresses Issued - IPaddNum/ CIDRNetDescrip	Note: Host IP Addresses are Not, and Can not Be Used for a Direct Active Connection. They can only be Used in conjunction with a Requestor / Server, as a Client having a Subordinate function, which defines a Host	
All 000/00:8	IANA - Reserved	Sep 81
1 001/00:8	IANA - Reserved	Sep 81
1 002/00:8	IANA - Reserved	Sep 81
1 003/00:8	General Electric Company	May 94
1 004/00:8	Bolt Beranek and Newman Inc.	Dec 92
1 005/00:8	IANA - Reserved	Jul 95
1 006/00:8	Army Information Systems Center	Feb 94
1 007/00:8	IANA - Reserved	Apr 95
1 008/00:8	Bolt Beranek and Newman Inc.	Dec 92
1 009/00:8	IBM	Aug 92
1 010/00:8	IANA - Private Use	Jun 95
1 011/00:8	DoD Intel Information Systems	May 93
1 012/00:8	AT&T Bell Laboratories	Jun 95
1 013/00:8	Xerox Corporation	Sep 91
1 014/00:8	IANA - Public Data Network	Jun 91
1 015/00:8	Hewlett-Packard Company	Jul 94
1 016/00:8	Digital Equipment Corporation	Nov 94
1 017/00:8	Apple Computer Inc.	Jul 92
1 018/00:8	MIT	Jan 94
1 019/00:8	Ford Motor Company	May 95
1 020/00:8	Computer Sciences Corporation	Oct 94
1 021/00:8	DDN-RVN	Jul 91
1 022/00:8	Defense Information Systems Agency	May 93
1 023/00:8	IANA - Reserved	Jul 95
1 024/00:8	ARIN - Cable Block (Formerly IANA - Jul 95)	May 01

E Terrell

[Page 45]

1	025/00:8	Royal Signals and Radar Establishment	Jan 95
1	026/00:8	Defense Information Systems Agency	May 95
1	027/00:8	IANA - Reserved	Apr 95
1	028/00:8	DSI-North	Jul 92
1	029/00:8	Defense Information Systems Agency	Jul 91
1	030/00:8	Defense Information Systems Agency	Jul 91
1	031/00:8	IANA - Reserved	Apr 99
1	032/00:8	Norsk Informasjonsteknologi	Jun 94
1	033/00:8	DLA Systems Automation Center	Jan 91
1	034/00:8	Halliburton Company	Mar 93
1	035/00:8	MERIT Computer Network	Apr 94
1	036/00:8	IANA - Reserved	Jul 00
		(Formerly Stanford University - Apr 93)	
1	037/00:8	IANA - Reserved	Apr 95
1	038/00:8	Performance Systems International	Sep 94
1	039/00:8	IANA - Reserved	Apr 95
1	040/00:8	Eli Lily and Company	Jun 94
1	041/00:8	IANA - Reserved	May 95
1	042/00:8	IANA - Reserved	Jul 95
1	043/00:8	Japan Inet	Jan 91
1	044/00:8	Amateur Radio Digital Communications	Jul 92
1	045/00:8	Interop Show Network	Jan 95
1	046/00:8	Bolt Beranek and Newman Inc.	Dec 92
1	047/00:8	Bell-Northern Research	Jan 91
1	048/00:8	Prudential Securities Inc.	May 95
1	049/00:8	Joint Technical Command	May 94
		Returned to IANA	Mar 98
1	050/00:8	Joint Technical Command	May 94
		Returned to IANA	Mar 98
1	051/00:8	Department of Social Security of UK	Aug 94
1	052/00:8	E.I. duPont de Nemours and Co., Inc.	Dec 91
1	053/00:8	Cap Debis CCS	Oct 93
1	054/00:8	Merck and Co., Inc.	Mar 92
1	055/00:8	Boeing Computer Services	Apr 95
1	056/00:8	U.S. Postal Service	Jun 94
1	057/00:8	SITA	May 95
1	058/00:8	IANA - Reserved	Sep 81
1	059/00:8	IANA - Reserved	Sep 81
1	060/00:8	IANA - Reserved	Sep 81
1	061/00:8	APNIC - Pacific Rim	Apr 97
1	062/00:8	RIPE NCC - Europe	Apr 97
1	063/00:8	ARIN	Apr 97
1	064/00:8	ARIN	Jul 99
1	065/00:8	ARIN	Jul 00
1	066/00:8	ARIN	Jul 00
1	067/00:8	ARIN	May 01
1	068/00:8	ARIN	Jun 01

10	069-079/00:8	IANA - Reserved	Sep 81
1	080/00:8	RIPE NCC	Apr 01
1	081/00:8	RIPE NCC	Apr 01
14	082-095/00:8	IANA - Reserved	Sep 81
31	096-126/00:8	IANA - Reserved	Sep 81
1	127/00:8	IANA - Reserved	Sep 81
64	128-191/00:8	Various Registries	May 93
1	192/00:8	Various Registries - MultiRegional	May 93
1	193/00:8	RIPE NCC - Europe	May 93
1	194/00:8	RIPE NCC - Europe	May 93
1	195/00:8	RIPE NCC - Europe	May 93
1	196/00:8	Various Registries	May 93
1	197/00:8	IANA - Reserved	May 93
1	198/00:8	Various Registries	May 93
1	199/00:8	ARIN - North America	May 93
1	200/00:8	ARIN - Central and South America	May 93
1	201/00:8	Reserved - Central and South America	May 93
1	202/00:8	APNIC - Pacific Rim	May 93
1	203/00:8	APNIC - Pacific Rim	May 93
1	204/00:8	ARIN - North America	Mar 94
1	205/00:8	ARIN - North America	Mar 94
1	206/00:8	ARIN - North America	Apr 95
1	207/00:8	ARIN - North America	Nov 95
1	208/00:8	ARIN - North America	Apr 96
1	209/00:8	ARIN - North America	Jun 96
1	210/00:8	APNIC - Pacific Rim	Jun 96
1	211/00:8	APNIC - Pacific Rim	Jun 96
1	212/00:8	IPE NCC - Europe	Oct 97
1	213/00:8	RIPE NCC - Europe	Mar 99
1	214/00:8	US-DOD	Mar 98
1	215/00:8	US-DOD	Mar 98
1	216/00:8	ARIN - North America	Apr 98
1	217/00:8	RIPE NCC - Europe	Jun 00
1	218/00:8	APNIC - Pacific Rim	Dec 00
1	219/00:8	APNIC	Sep 01
1	220/00:8	APNIC	Dec 01
3	221-223/00:8	IANA - Reserved	Sep 81
16	224-239/00:8	IANA - Multicast	Sep 81
16	240-255/00:8	IANA - Reserved	Sep 81

-----|
Note: Host IP Addresses are determined by the 'IPt1' Addressing
Schematic, and can Not Be Used for / to Establish A Direct
Internet Connection (Connection Outside of its Network Domain)
-----|

TABLE 10

Internet Protocol t1 Address Space INDEX

IPaddNum = Network IP Address

CIDRNetDescrip = CIDR Network Descriptor

Current Number of IP Network Addresses Issued

Accounts for = 253 IP Network Addresses

	Class A	CIDR Network Descriptor
A-1:	Issued = 127 , Remaining = 1,040,513,921	/00:08
A-2:	Issued = None, Remaining = 516,160,512	/00:16
A-3:	Issued = None, Remaining = 256,048,128	/00:24
A-4:	Issued = None, Remaining = 252,047,376	/00:32
Class B		
B-1:	Issued = 64 , Remaining = 784,514,496	/10:08
B-2:	Issued = None, Remaining = 197,672,960	/10:16
B-3:	Issued = None, Remaining = 49,807,360	/10:24
B-4:	Issued = None, Remaining = 16,777,216	/10:32
Class C		
C-1:	Issued = 32 , Remaining = 458,321,632	/110:08
C-2:	Issued = None, Remaining = 57,741,312	/110:16
C-3:	Issued = None, Remaining = 7,274,496	/110:24
C-4:	Issued = None, Remaining = 1,048,576	/110:32

Class D

D-1:	Issued = 16	, Remaining = 245,676,912	/1110:08
D-2:	Issued = None,	Remaining = 15,475,712	/1110:16
D-3:	Issued = None,	Remaining = 974,848	/1110:24
D-4:	Issued = None,	Remaining = 65,536	/1110:32

Class E

E-1:	Issued = 15	, Remaining = 231,289,845	/1111:08
E-2:	Issued = None,	Remaining = 13,658,850	/1111:16
E-3:	Issued = None,	Remaining = 806,625	/1111:24
E-4:	Issued = None,	Remaining = 50,625	/1111:32

Appendix II: Mathematical Analysis of the Structure, and the Definition
of the IPTX Protocol(s) Addressing System. (Part1)

The 'IPTX' is a System of Addressing Protocol Specifications; An Internet Protocol 't'ele-communications Specification having an Unlimited Size, or Capacity, equaling the Number representing the displacement of the 'IP Bit' Mapped Address Space, which is used to Establish Communications between Networked Computers. This Protocol Specification represents a Mathematical Series of a Class of Protocols, a Numbering System that Increases in 32 Bit Increments, or Some Multiple of 32, which is represented by the Number Specified, and Replaced in the 'X' notation used in the name; 'IPTX'. Furthermore, this is Protocol Addressing System that represents a Class of Addressing Specifications, which are completely Backward Compatible, in nearly every respect, with the IPv4 Addressing Specification (See Tables 8 and 11).

Nevertheless, while the 'IPT1' is the only Protocol, the first addressing protocol in this specification, which has complete compatibility with the IPv4 specification. The difference between the IPv4 Protocol and the other protocols derived from the 'IPTX Specification', is their Addressing Schematic, which requires a Different 'Application Program Interface' that would used with the 'NIC Driver' to allow Network Cards (NIC) to Bind to the Prefixes used in the format describing these Addressing Specifications (See Table 11). Needless to say, my suggestion would be, the Development of an Application (GUI), which allows the User to direct their communications via Continent (Zone IP) and the respective Country / State / Province (IP Area Code) of the Recipient.

TABLE 11

Ipt1 32 Bit Mapped Address Space

32 Bit IPT1 Address Space	CIDR Network Descriptor
XXX.XXX.XXX.XXX	/XXXX:XX

Ipt2 64 Bit Mapped Address Space

Prefix Address <---> (Or Trunk Identifier)				32 Bit IPT1 Address Space	CIDR Network Descriptor
/	/	\	\		
8 Bits	8 Bits	8 Bits	8 Bits		
Reserved:	Reserved:	Zone IP:	IP Area Code:	XXX.XXX.XXX.XXX	/XXXX:XX

Ipt3 96 Bit Mapped Address Space

Prefix Address Bit Count (Or Trunk Identifier)						32 Bit IPT1 Address Space	CIDR Network Descriptor		
/	/	\	\						
8	8	8	8	8	8	8 Bits	8 Bits		
R:	R:	R:	R:	R:	R:	Zone IP:	IP Area Code:	XXX.XXX.XXX.XXX	/XXXX:XX

Ipt4 128 Bit Mapped Address Space

Prefix Address Bit Count (Or Trunk Identifier)										IPT1 Address Space	CIDR Network Descriptor			
/	/	\	\											
8	8	8	8	8	8	8	8	8	8	8	8 Bits	8 Bits		
R:	R:	R:	R:	R:	R:	R:	R:	R:	R:	R:	Zone IP:	IP Area Code:	32 Bit	/XXXX:XX

The Future; which Suggest a Different Reality regarding the Internet and Networking, using the IPTX Protocol Specification. (Part2)

The Future of the Internet promises an Always On, for everyone, in a Always Connected World. In fact, it will become a necessity for many, because there are many devices, using the current technology, which would be Medically vital, to sustain life.

1. Bluetooth Wireless; Transmitting Biorhythms, read from a Biorhythm Watch for example, that would monitor a 'Heart Patient', and that could Dispatch an Ambulance during an Emergency.

2. Personal Email, operated from Trunk or Backbone Server (Storage Station), transmitted to the Personal Email Server assigned to every Personal Intranet-Network. This however, would require a New Email Naming Convention, which would allow everyone to always have an email address to match their place of residence; e.g.:
'john.doe@ip area code:zone ip/XXXX:XX', which translates to, 'john.doe@255:255/00:8'. Where the DNS values could be equivalent to (Or actually, would not be necessary, because as long as the First and Last Names are Unique the Email would find its' Destination);

Last Name = Network Address, and
First Name = host Address

3. Internet Television and the elimination of the 'Tuner'; while having Graphics Superior to 'HDTV', and total Interactive Control. The 'Internet TV' would see the elimination of the Turner Hardware Device, which would still exist in principle. Because instead of Changing Channels in Hardware, a person would be Changing IP Addresses, which are using Video Streaming to Broadcast almost the same (except for the advantages regarding total Interactive Control) TV Broadcasted via some Radio Spectrum Frequency. In other words, Changing the Tuner to an IP Address Channel could be Free, when broadcasted using only a 32 Bit IP Address, and Pay, when using Zone IP and IP Area Code Addresses: e.g.; Channel '7' could be 234.44.123.007 for normal Broadcast...And Pay Broadcast could be delivered from anywhere in the world, because all that would be needed to represent the Channel is the 'Zone IP: IP Area Code: Network IP Address'.

4. IP Telephoning could use the same Billing Type Structure, which would mean either Packaging everything, having only 1 cost, or a substantial reduction in the Monthly Phone Bill for the average Consumer.
5. Networked Personal Automobiles: Every individual having the Control, Remote Wireless, over the Locking, Unlocking, Location, and Alarm Devices connected to their Automobiles, because it is now a Host on their Network. And in the event their Automobile was stolen, the Location GPS Code used by their Software would be given to the Police to locate their stolen vehicle. And all of these Devices would be required, or the Vehicle would not operate, which would prevent any disabling of these devices.
6. Real Time Monitoring of the 'Black Boxes' used by the Airlines to Monitor Voice Communications, and Aircraft System Functions.
7. LNAV: Land Navigation Control System, Devices located on the ground, which would provide Navigation Control and Geographical Location Information, to free up Satellite Transmissions that could be used for: Guidance and Flight Control of Airplanes during Emergencies; To provide Communications in Remote areas where Cabling is not possible; Airlines Blackbox Monitoring; And to provide a Overall Back-up, for the 'Global Wide Emergency Broadcast System' (or GWEBS).

Nevertheless, while these were only examples, they exist as Real World Possibilities, because most of the required technology is currently on the shelf. Even still, with the implementation of these Protocol Specifications, the possibility for living the future, during my life, is indeed a possibility today.

Appendix III: Consolidation of Infinity; The Reality of the 2 Tier Base
Foundation of the 'IPtX' Protocol Family Specification

The IPtX Protocol Specification represents a Class, or a 'Family' of IP Addressing Protocols in total compliance with RFC 1550, which contains a Mathematical Series of Addressing Specifications that are completely compatible, in nearly every respect, with the IPv4 Addressing Specification.

Definition 1

"The IPtX Protocol Specification: An Internet Protocol Telecommunication Specification having an Unlimited Size, or Capacity, which equals the Number representing the displacement of the 'IP Bit Mapped Address Space' that specifies the Size of the Header being used. 'That is, it is the Header size, which distinguishes, or can be used to determine the particular Addressing Protocol contained within this Family of Addressing Protocols that is used to Establish Communications between Networked Computers'."

In other words, this is a Protocol Specification that represents a Mathematical Series containing a Class of Protocol Specifications, which represents a Numbering System that Increases in 32 Bit Increments, or Some Multiple of 32 that is distinguished by the Number Specified, and used in place of the 'X' notation (or Variable) specified in the name; 'IPtX'. Furthermore, it is important to note, this is Protocol Addressing System that offers or provides a gradual and controllable growth, which actually represents an Infinite Class of Addressing Specifications that are completely Backward Compatible, in nearly every respect, with the IPv4 IP Addressing System.

The foundation, or base, which provides the 'IPtX Protocol Family' its unprecedented versatility is derived from and built upon the Schematic Design of the 'IPt1 and IPt2' Specifications, as depicted in Tables 3 through 5. While figures 1 through 3 provides an example of the possible Header Construction these Specifications could use, (noting specifically that the IPt1 specification requires absolutely no change from the existing Header Design used in the current IPv4 Specification) and the format of the default Addressing structure used in the IPt2 specification.

Figure 1

IP Header for IPv4 and IPT1

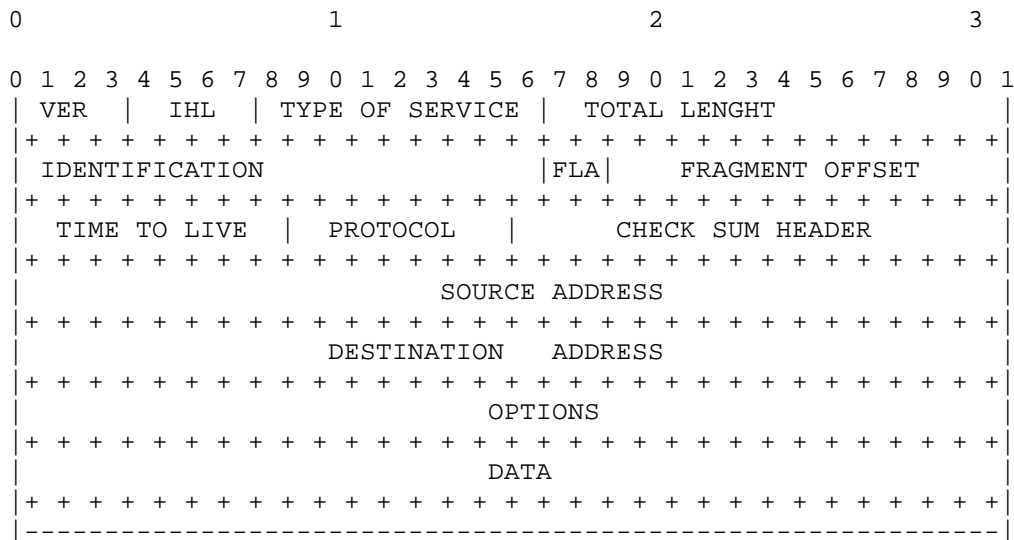
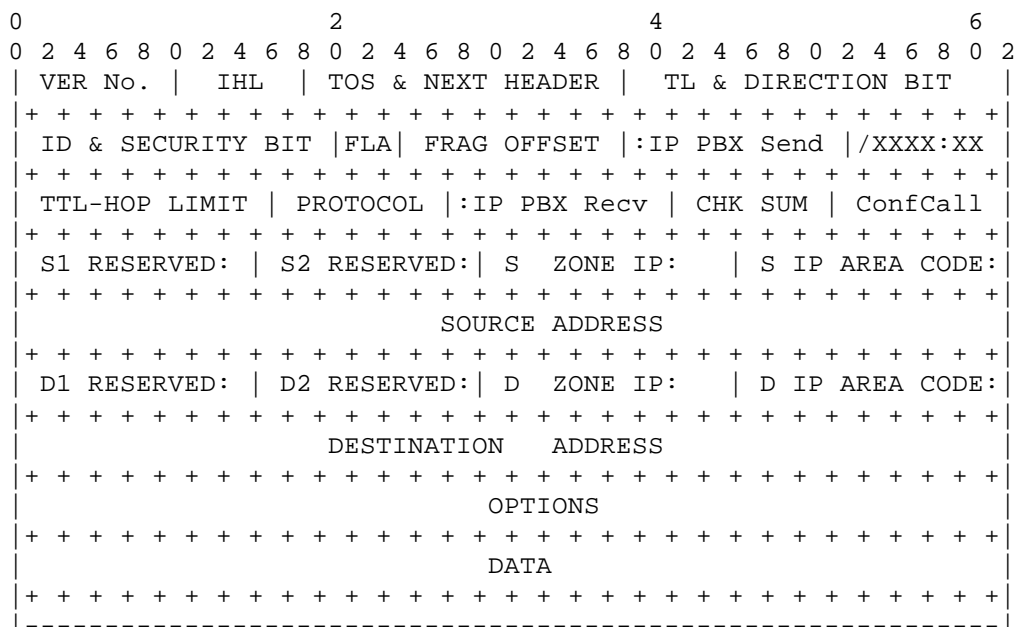

Figure 2

IP Header for IPT2



This is a Proposal, an example notwithstanding, whose graphical depiction is indeed functional. Where by, the TTL and Hop Limit are program functions related to the Router's Table. And the Security Bit is a 2 Bit representation of some combination of 01, and 00. Where a '01' in the first bit tells the Router to route as a Direct Connection, and a '01' in the second Bit tells the Router that the transmission is Encrypted. While Type Of Service remains unchanged and Next Header is a '1' Bit indicator, being either a '01' or a '00'. Nevertheless, while the Total Length increases to 64 Bits, it can retain this size specification regardless of size of IP Bit Mapped Address Space, because a Direction Bit of either a '01' or '00' tells the Router if the Packet is an InterCom or OuterCom Communication. Furthermore, the Header could also specify not only the 'CIDR Network Descriptor', /XXXX:XX, but it could include the ability to write the '2' way 'IP PBX Extension' for VVoIP Transmissions, and allow Conference Calls (ConfCall).

FIGURE 3

'Reality of the IP Addressing Format in the 64 Bit Header'
'Whose Reserved Addresses would not be apart of the Software
Program representing the Header'

1. Source Address Structure: (X.X.X):(X.X.X):256:256:256.256.000.000
2. Destination Address Structure: (X.X.X):(X.X.X):256:256:256.256.000.000

Note*: While the expansion of the IP Address within the Header, is incremented in '8 Bit' Segments. The increase in the Total Size of the IP Address beyond the Current Header Specifications, is accomplished using '32 Bit' increments, which increases the overall size of the Header itself. This is, as it should be, because it reflects the size of the 'Base IP Addressing Schematic'; 'IPT1'. Thus, preserving the Logic and Mathematical Continuity, which is the actual integrity of the System's Foundation, that was logically derived from the Mathematics of Quantification.

Nevertheless, perhaps the greatest benefit from using the 'IPtX Specification', is that; 'The Client's Side of this IP Addressing Specification Can Remain Constant, or Limited to only '48 Bits', because the IPtX Protocol Family Actually Represents a '2' Tier Base Configuration. In other words, the 'IPtX Specification' maintains a Base Foundation that contains '2' distinct Parts, which uses 32 Bits in the 'IPt1' Specification (First Base Foundation), and 64 Bits in the 'IPt2' Specification (Second Base Foundation). What this means, is that the 'Second Base Foundation' represents the 'Consolidation of Infinity', which would Limit the Size of the Header Specification to 64 Bits, regardless of the Size that the Protocol Address actually displayed in the 'IP Bit Mapped Address Space' (which is the actual Binary Number representing the Protocol Addressing). However, the use of this added feature in the 'IPtX Protocol Family Specification' is dependent in part on the Design of the Topology of Internet Backbone, and the IP Address Assignment of the 'Connecting Boundary Router', or Zone (IP) Routers. Which is to say, while the IPtX Protocol Family Specification can be Implemented Without the Internet Backbone Topology having a Hierarchy, (Using only the First Base foundation) without a Hierarchy for the Internet Backbone Topology the Second Base Foundation can not be used.

In other words, what this actually implies Mathematically, is that, the 'Trunk Identifier', or 'Connecting Boundary Router's' Designation could be reduced in Size, and Specified in the Header, because accepting that the IP Address used by the Client, or Network Domain Engineer, actually represents the IP Address used to Connect networked Computers, then All other Bits used in the IP Address could be used to Identify the 'Connecting Boundary Router'. This procedure would result in a 'Router's Designation' that could be specified as consisting of the combination of the Router's 'MAC Address' and the 'Zone IP Address'. Which could also be used to indicate the Location where the 'Connecting Boundary Router' resides within the 'ZONE IP Address Space'. Furthermore, since 'Connecting Boundary Router' is in fact the Point of 'Demarcation', all other IP Addresses within the 'Zone IP' Address Space (or Internet Protocol t2 Address Space) to Remain Unique. Moreover, if a greater expansion of the IP Bit Mapped Address Space were required, as would be needed to specify the Galaxies and Solar Systems connecting the people in a Universal Networked Community, the entire 64 Bit Address Space in the IPt2 Specification could be used to allow such an expansion. Even still, the 64 Bit IP Bit Mapped Address Space could quite easily represent the maximum size for the Client's Connection, because the 'Connecting Boundary Router' IP Address could actually absorb all of the remaining Bits used to specify the IP Bit Mapped Address Space.

Table 12

'IPTX Protocol Family'
 (Topology of Internet Backbone With Hierarchy)

Addressing Specification		Number Of BITS		Header Size Specification
IPt1	=	32 Bit	=	32 Bit
IPt2	=	64 Bit	=	64 Bit
IPt3	=	96 Bit	=	64 Bit
IPt4	=	128 Bit	=	64 Bit
IPt5	=	160 Bit	=	64 Bit
.
.
.
IPt8	=	256 Bit	=	64 Bit
.
.
.
IPt12	=	384 Bit	=	64 Bit
.
.
.
IPt18	=	576 Bit	=	64 Bit
.
.
.
IPt26	=	832 Bit	=	64 Bit
.
.
.
IPt32	=	1024 Bit	=	64 Bit
.
.
.
IPt57	=	1824 Bit	=	64 Bit
.
.
.
IPt64	=	2048 Bit	=	64 Bit
.
.
.

```

IPT100      =   3,200 Bit   =   64 Bit
.           .             .     .     .
.           .             .     .     .
.           .             .     .     .
IPT5003     =  160,096 Bit =   64 Bit
.           .             .     .     .
.           .             .     .     .
.           .             .     .     .
IPTX        = Infinite Number of Bits = 64 Bit

```

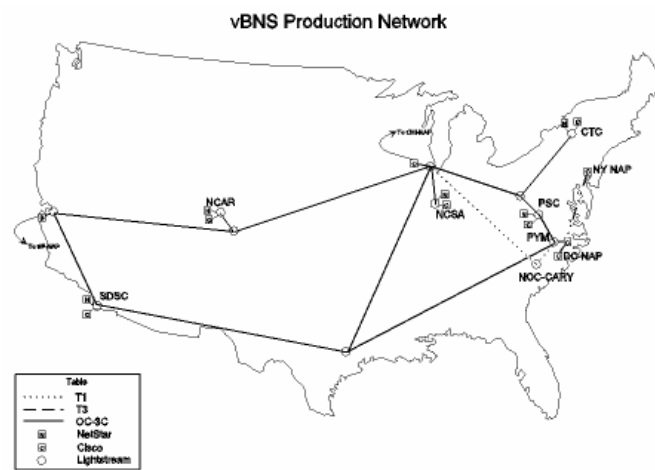

Figure 4-A: Current Internet Backbone

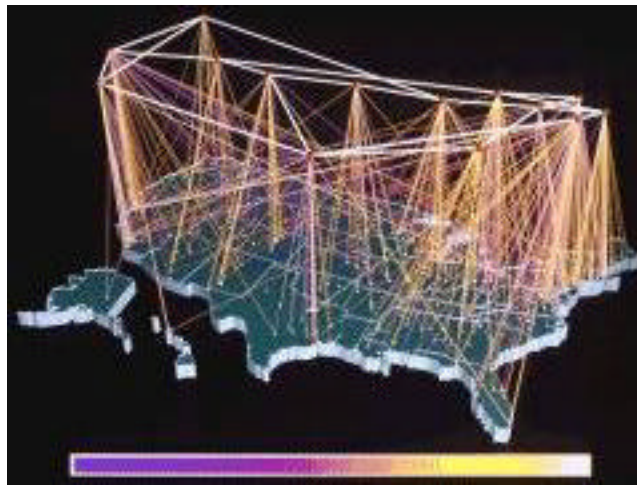

Figure 5-A: NA Zone IP = 001; Backbone Connections



Figure 6-A: Graphical Depiction; NA= Zone IP= 001, Backbone

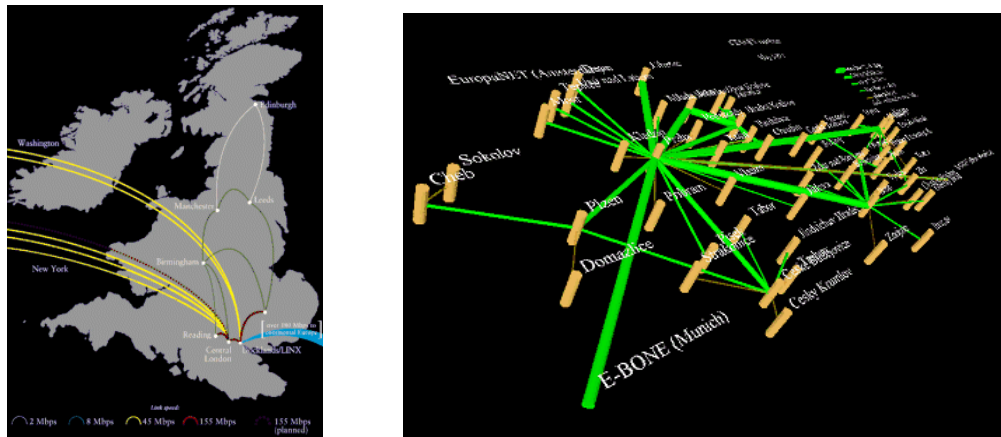

Figure 7-A; EU = Zone IP = 003; Backbone Connections

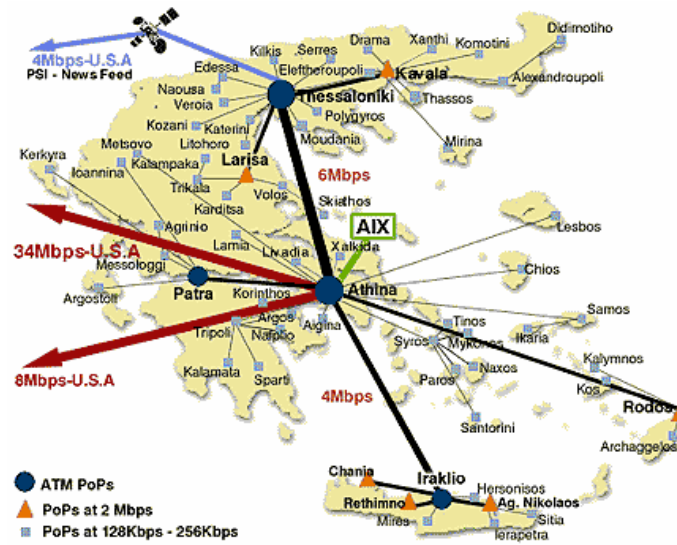
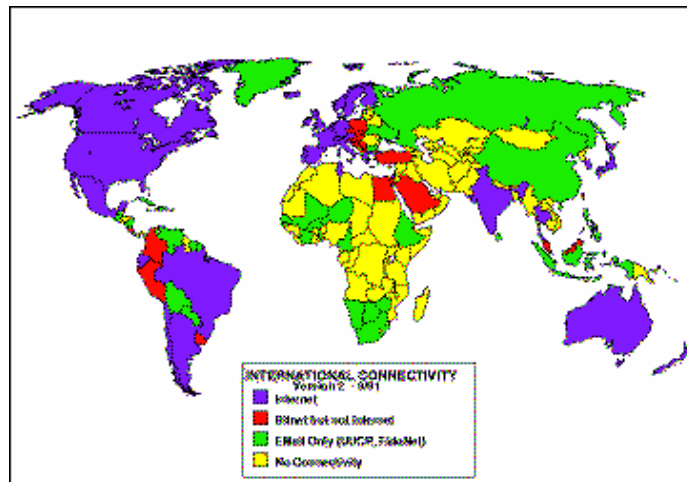



Figure 8-A: The Global Backbone of the World



Figure 9-A: The Internet Activity of the World



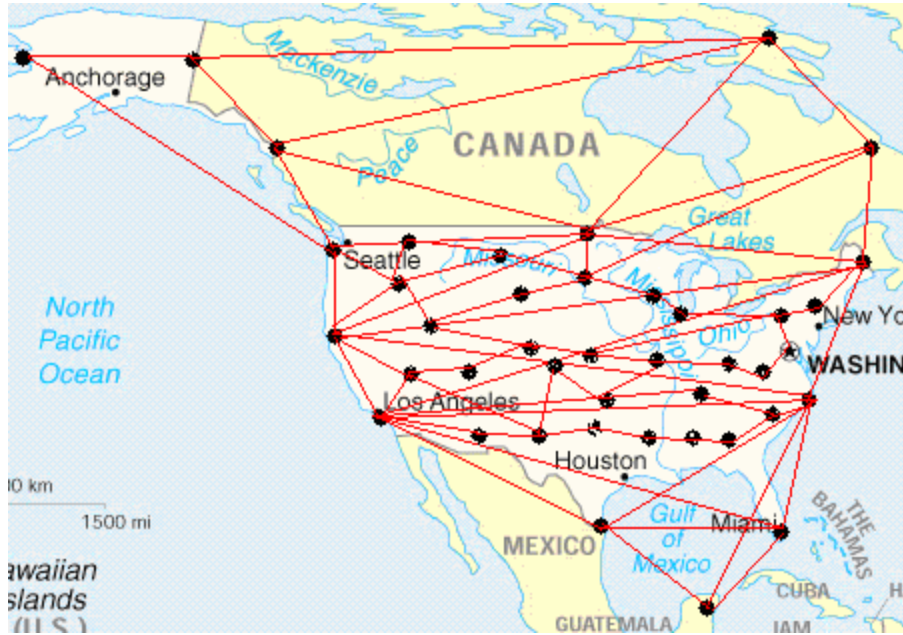
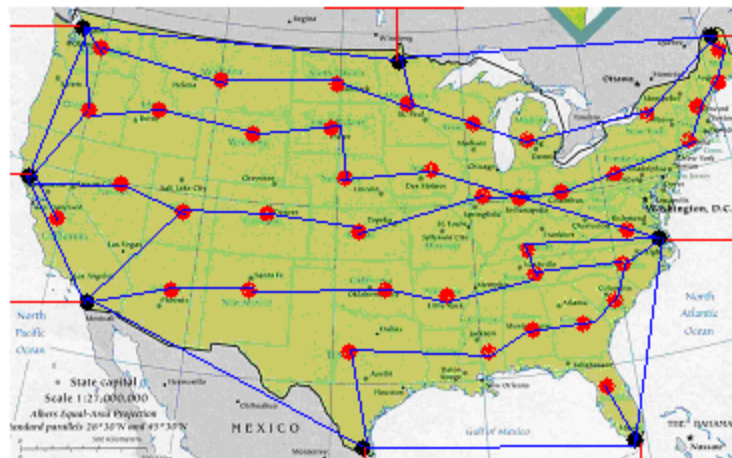
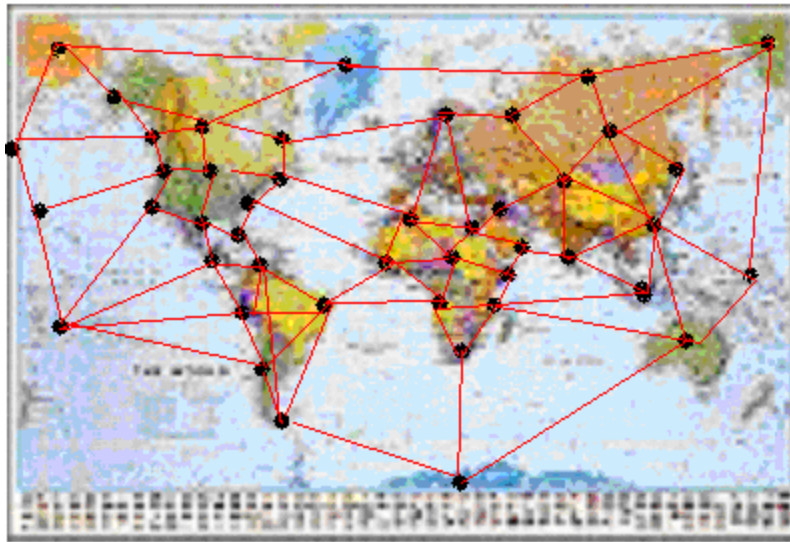

Figure 10-A: NA = Zone IP = 001; Having Multiple Backbone Connections



Black Dot = Zone IP / IP Area Code Router
Red Dot = IP Area Code Address Backbone Connection

Figure 11-A: Different 'IP Area Code' Backbone Connections



**Black Dots = Border Backbone Connections =
Zone IP / IP Area Code = Routers**

Figure 12-A: Zone IP = Border Routers

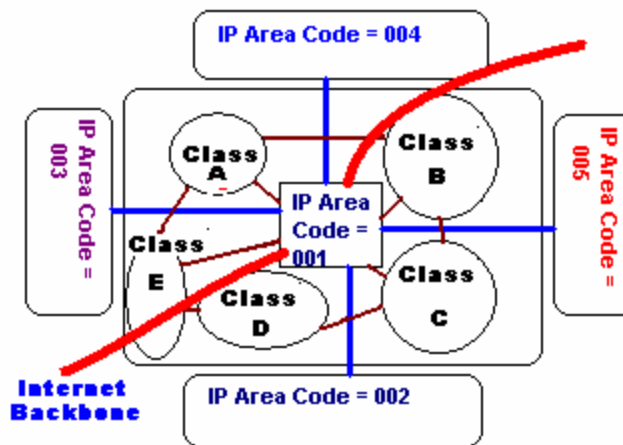

Figure 13-A: Hierarchical Configuration of an IP Area Code Location

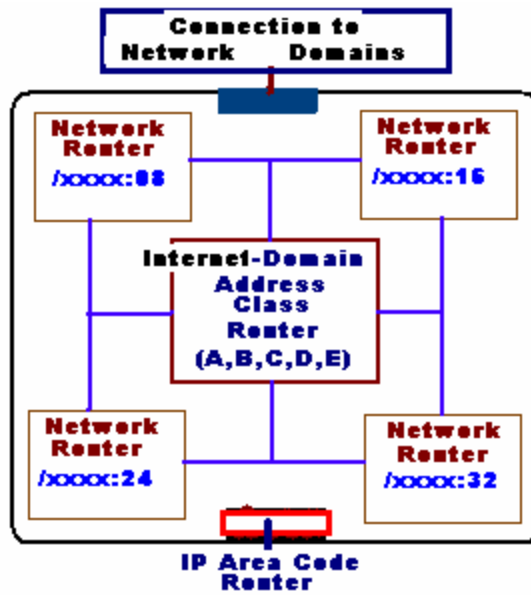

Figure 14-A: Hierarchical Configuration for Network Routing in an IPT1 Address Space

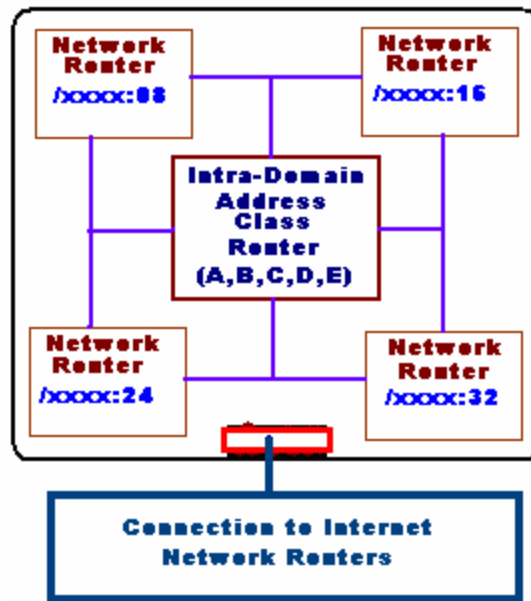

Figure 15-A: Network-Domain configuration

References

1. E. Terrell (not published notarized, 1979) " The Proof of Fermat's Last Theorem: The Revolution in Mathematical Thought" Outlines the significance of the need for a thorough understanding of the Concept of Quantification and the Concept of the Common Coefficient. These principles, as well many others, were found to maintain an unyielding importance in the Logical Analysis of Exponential Equations in Number Theory.
2. E. Terrell (not published notarized, 1983) " The Rudiments of Finite Algebra: The Results of Quantification " Demonstrates the use of the Exponent in Logical Analysis, not only of the Pure Arithmetic Functions of Number Theory, but Pure Logic as well. Where the Exponent was utilized in the Logical Expansion of the underlying concepts of Set Theory and the Field Postulates. The results yield; another Distributive Property (i.e. Distributive Law for Exponential Functions) and emphasized the possibility of an Alternate View of the Entire Mathematical field.
3. G Boole (Dover publication, 1958) "An Investigation of The Laws of Thought" On which is founded The Mathematical Theories of Logic and Probabilities; and the Logic of Computer Mathematics.
4. R Carnap (University of Chicago Press, 1947 / 1958) "Meaning and Necessity" A study in Semantics and Modal Logic.
5. R Carnap (Dover Publications, 1958) " Introduction to Symbolic Logic and its Applications"
6. C. Huitema (INRIA, November 1994), RFC 1715; "The H Ratio for Address Assignment Efficiency".
7. Authors: Durand, A. and Huitema, C., "The Host-Density Ratio for Address Assignment Efficiency: An update on the H ratio", RFC 3194, SUN Microsystems/Microsoft, November 2001.
8. Authors: Scott Bradner, and Allison Mankin; RFC1550 "IP: Next Generation (IPng) White Paper Solicitation"

Author:
Eugene Terrell
24409 Soto Road Apt. 7
Hayward, CA. 94544-1438
Voice: 510-537-2390
E-Mail: eterrell00@netzero.net

"Copyright (C) The Internet Society (4/15/02). All Rights Reserved.

This document and translations of it may be copied and furnished to others, and derivative works that comment on or otherwise explain it or assist in its implementation may be prepared, copied, published and distributed, in whole or in part, without restriction of any kind; except when such works are sold without the consent of the Author and are not freely distributed, and provided that the above copyright notice and this paragraph are included on all such copies and derivative works. Furthermore, this document itself may not be modified in any way, such as by removing the copyright notice or references to the Internet Society or other Internet organizations, except as needed for the purpose of developing Internet standards in which case the procedures for copyrights defined in the Internet Standards process must be followed, or as required to translate it into languages other than English.

The limited permissions granted above are perpetual and will not be revoked by the Internet Society or its successors or assigns, except that the Author is not bound by any of the provisions set forth herein, or outline by this Copyright.

This document and the information contained herein is provided on an "AS IS" basis and THE INTERNET SOCIETY AND THE INTERNET ENGINEERING TASK FORCE DISCLAIMS ALL WARRANTIES, EXPRESS OR IMPLIED, INCLUDING BUT NOT LIMITED TO ANY WARRANTY THAT THE USE OF THE INFORMATION HEREIN WILL NOT INFRINGE ANY RIGHTS OR ANY IMPLIED WARRANTIES OF MERCHANTABILITY OR FITNESS FOR A PARTICULAR PURPOSE."